



KEFRANCE
STORES D'EXTERIEUR

LA SOCIÉTÉ

L'entreprise KE FRANCE, forte de plus de 30 ans d'existence est spécialisée dans les stores extérieurs. Ces derniers mois, cette gamme s'est étendue aux volets roulants, screeny et aux solutions d'aménagement couvert de terrasses.

Implantés depuis plus de 20 ans au cœur de la Région Centre, nos ateliers de plus de 5 000m² offrent les avantages d'une production sur mesure française nous permettant de fabriquer l'ensemble de la gamme que vous allez découvrir.



QUALITÉ & SÉCURITÉ

Pour répondre à ces exigences, KE FRANCE travaille avec un équipement et un personnel qualifié en conformité avec la réglementation européenne.

Dans sa démarche qualité, KE FRANCE est également appuyé par des organismes de certification reconnus universellement, qui assurent la production et la validité de qualification, de documentation et de test pour les produits répondant à cette norme et certifiés CE.

Ces vérifications garantissent la résistance au vent, l'effort de manœuvre et la résistance à la poche d'eau.

LOCALISATION



Retrouvez toutes les infos sur notre site internet :
www.kefrance.fr





**BANNES
MONOBLOCS
& LOGGIAS**

NUOVA BALI/HAWAI	4
GENEROSA & GENEROSA PLUS	5
MODERNA	6
FUTURA	7
LOGGIA	8



**BANNES
SEMI-COFFRES
& COFFRES**

PALLADIO	9
COMPACTO	10
ELISSE	11
OPTIMA	12
ARMONY PLUS	13



**STORES
VERANDAS**

VERANDA	14
VERANDA PLUS	15



**X-TENSION &
VELUM**

X-TENSION	16
VELUM	17



**STORES
DE JARDIN**

TOBAGO	18
DUO-PENTA STYLE	19
SICURA	20
SALINA & LIPARI	21



**STORES
PROJECTION**

ANTIQUE	22
CAMANOE PROJECTION	23
BANNETTE PROJECTION	23



**STORES
VERTICAUX**

CAMANOE VERTICAL	24
BANNETTE VERTICALE	24



**VOLETS
ROULANTS**

VOLETS ROULANTS RENOVATION	26
VOLETS ROULANTS TRADITIONNELS	27



MARQUISES

ELENA	28
DIONISIO	28
ELISSA	28

KIT LUMIÈRE / KIT LUMIÈRE ET MUSIQUE

1 700 mm ou 3 400 mm
4 enceintes, puissance 2 X 40 w
4 ou 8 spots halogènes, basse tension,
de 20 Watts

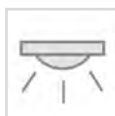

KIT CHAUFFAGE

120 x 830 mm
Puissance de 1800 Watts, lampe à quartz
avec filament en Tungstène, couverture de
4 à 6 m²

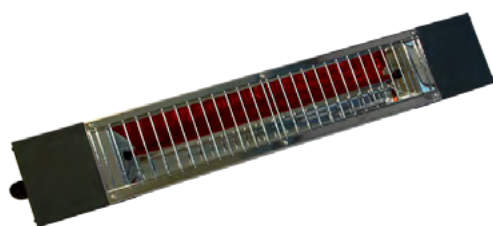
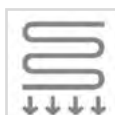

PERCHE TÉLESCOPIQUE AMOVIBLE

1500 à 2500 mm
En alu, avec platine de fixation au sol
en inox, qui permet de stabiliser le store
par vent léger et de maintenir la barre de
charge



LAMBREQUIN DÉROULABLE

Manœuvre treuil ou motorisé



AUVENT DE PROTECTION

Permet de protéger la toile des
intempéries.





Les armatures sont, selon les modèles en standard en Blanc , Perle , Gris Clair et Gris foncé Fine Structure , mais il existe d'autres possibilités.

TEINTES RAL SPÉCIFIQUES sélection KE FRANCE

NOIR*
SABLÉ

* De série sur certains produits

RAL 1000	RAL 1001	RAL 1011	RAL 1014	RAL 1015		
RAL 6005	RAL 6018	RAL 6021	RAL 6024	RAL 6029		
RAL 5000	RAL 5002	RAL 5003	RAL 5010	RAL 5015		
RAL 7001	RAL 7005	RAL 7006	RAL 7011	RAL 7012	RAL 7015	RAL 7016
RAL 7021	RAL 7022	RAL 7024	RAL 7031	RAL 7035	RAL 7037	RAL 7043
RAL 8001	RAL 8007	RAL 8014	RAL 8019	RAL 8024		
RAL 9001	RAL 9002	RAL 9016	RAL 9005			

TEINTES RAL SPÉCIFIQUES hors sélection KE FRANCE

Toutes autres teintes RAL disponibles sur demande

ASPECTS SPÉCIFIQUES

Jouez sur les différents aspects de finition de votre store :
sablés, givrés, métallisés, satinés...







Coloris non-contractuels

NUOVA BALI/HAWAI

Store Banne monobloc

NOTRE MODÈLE ENTRÉE DE GAMME...

NUOVA BALI / HAWAI est une valeur sûre dans la famille des monoblocs. Proposée en 3 coloris de base : Blanc, Perle et Gris, elle peut aussi être déclinée dans un large choix de coloris spécifiques en option. NUOVA BALI / HAWAI peut également être équipée de nombreux accessoires tels que perche télescopique, auvent...

- COLORIS ▶**
- Blanc Ral 9010 
 - Perle Ral 1013 
 - Gris Ral 9006 
 - Laquage Ral spécifique 
- LARGEUR ▶** 1 810 à 14 140 mm.
- AVANCÉE ▶** 1 600 à 3 600 mm.

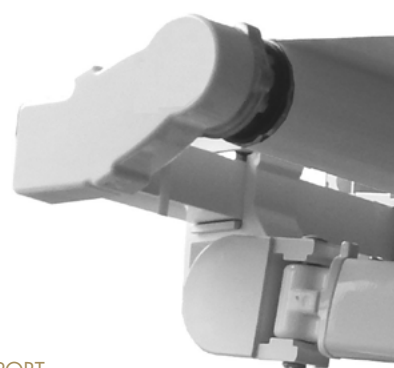

SUPPORT



NORMES



TYPES DE MANŒUVRES

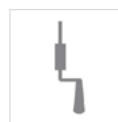

OPTIONS



GENEROSA & GENEROSA PLUS

Store Banne monobloc

POUR LES PLUS GRANDES LARGEURS ...

Permettant d'équiper les terrasses les plus grandes, les bannes monoblocs GENEROSA & GENEROSA PLUS vous proposent leurs très grandes dimensions allant jusqu'à 15 290 mm de largeur par 4 100 mm d'avancée. Disponibles en 3 coloris de base : Blanc, Perle et Gris Fine Structure, elles peuvent aussi être déclinées dans de nombreux coloris spécifiques en option. Ces bannes peuvent également être agrémentées d'un lambrequin déroulable motorisé.

- COLORIS ▶**
- Blanc Ral 9010 
 - Perle Ral 1013 
 - Gris Ral 7016 FS 
 - Laquage Ral spécifique 
- LARGEUR ▶** 1 370 à 15 290 mm.
- AVANCÉE ▶** 1 600 à 4 100 mm.

GENEROSA



GENEROSA PLUS

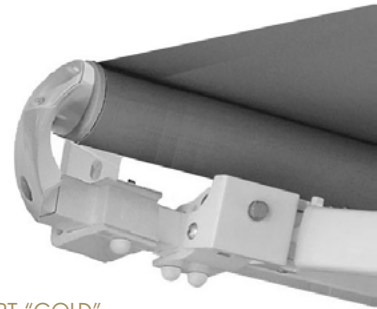

SUPPORT "GOLD"



NORMES



TYPES DE MANŒUVRES

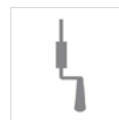

OPTIONS

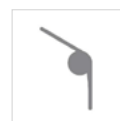

MODERNA

Store Banne monobloc

POUR LES PLUS GRANDES AVANCÉES ...

La banne monobloc MODERNA vous projette dans la plus grande avancée qui soit : 4 850 mm et ce jusqu'à 11 830 mm de largeur. Disponible en Perle Ral 1013, ce produit peut également être équipé de nos kits lumières ou chauffage. Cette banne est idéale pour les grandes terrasses (restaurants, cafés, bars ...) et permet d'adapter un auvent en option.

COLORIS ▶ Perle Ral 1013



LARGEUR ▶ 4 300 à 11 830 mm.

AVANCÉE ▶ 3 600 à 4 850 mm.

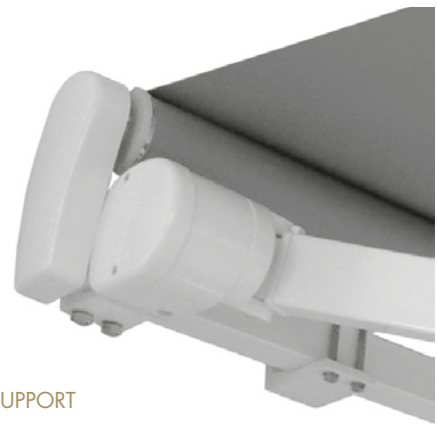
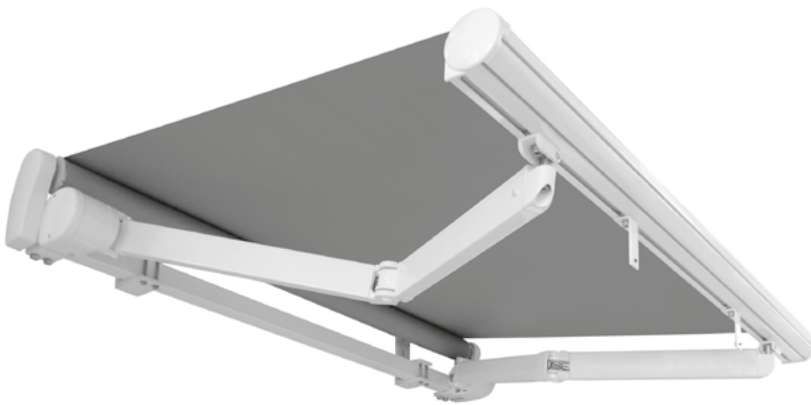

SUPPORT



NORMES



TYPES DE MANŒUVRES

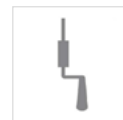

OPTIONS



FUTURA

Store Banne à bras indépendants

POUR SA ROBUSTESSE ...

Cette banne assurera une couverture optimale de votre terrasse. Avec des dimensions allant jusqu'à 11 830 mm de largeur par 4 600 mm d'avancée, la banne FUTURA ravira les inconditionnels des modèles précurseurs. Disponible en Perle de série, cette banne peut-être équipée d'un auvent ou bien de kits chauffage ou lumière.

COLORIS ▶ Perle Ral 1013



LARGEUR ▶ 4 300 à 11 830 mm.

AVANCÉE ▶ 3 600 à 4 600 mm.



SUPPORT



NORMES



TYPES DE MANŒUVRES



OPTIONS



LOGGIA

Store banne loggia

POUR TOUS LES TYPES DE POSES ...

Avec ses bras indépendants ou croisés et ses supports polyvalents de pose (face, plafond, tableau), c'est la banne idéale pour se jouer des façades irrégulières : étages, tuyaux, câbles n'ont qu'à bien se tenir ! Disponible en Blanc et Perle, la banne LOGGIA peut également accueillir un lambrequin déroulable motorisé en option.

COLORIS ▶ Perle Ral 9010



Perle Ral 1013



LARGEUR ▶ 1 350 à 5 940 mm.

AVANCÉE ▶ 1 600 à 3 100 mm.

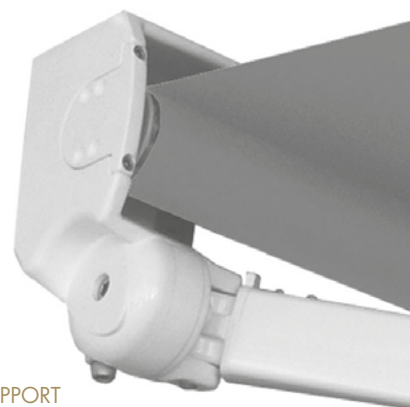
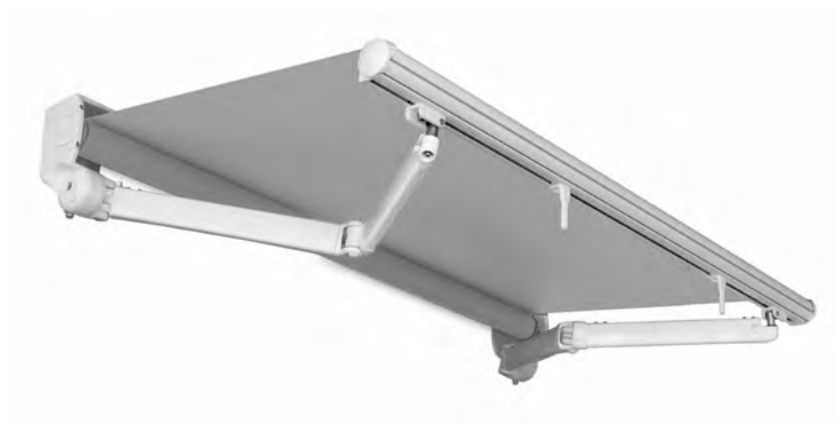

SUPPORT



NORMES



TYPES DE MANOEUVRES



OPTIONS

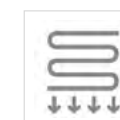
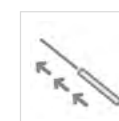

PALLADIO

Store banne semi-coffre

POUR SA DISCRÉTION ...

Unique semi-coffre de la gamme KE FRANCE la PALLADIO vous propose de généreuses dimensions maximales, tant en largeur (11 790 mm) qu'en avancée (4 100 mm). Disponible en Perle Ral 1013, le modèle PALLADIO peut-être équipé de nos kits lumières ou bien chauffage.

COLORIS ▶ Perle Ral 1013



LARGEUR ▶ 2 020 à 11 790 mm.

AVANCÉE ▶ 1 600 à 4 100 mm.

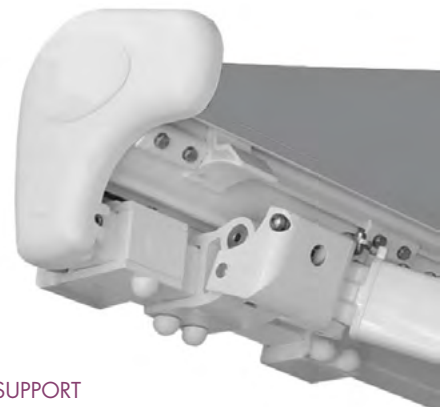

SUPPORT



NORMES



TYPES DE MANŒUVRES

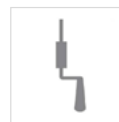

OPTIONS



COMPACTO

Store banne coffre

NOTRE ENTRÉE DE GAMME COFFRE ...

Bien que discret, son coffre protège aussi bien la toile que le mécanisme. Offrant des dimensions allant jusqu'à 5 500 mm de largeur par 3 100 mm d'avancée, la banne coffre COMPACTO est disponible en 3 coloris de base : Blanc, Perle et Gris Fine Structure, mais elle peut aussi être déclinée en laquages spécifiques en option.

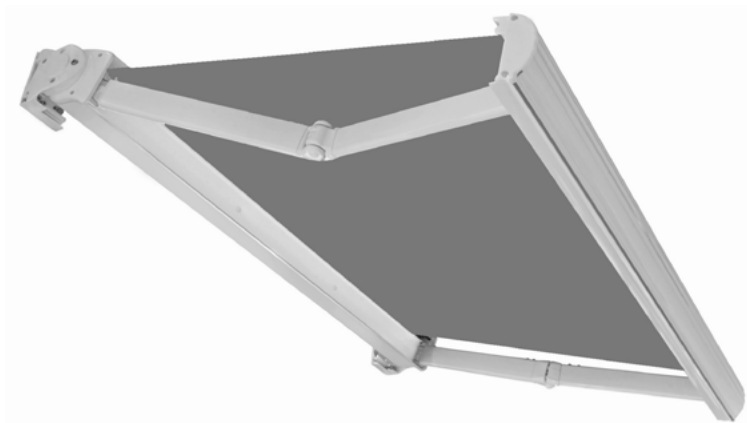

- COLORIS ▶**
- Blanc Ral 9010 
 - Perle Ral 1013 
 - Gris Ral 7016 FS 
 - Laquage Ral spécifique 
- LARGEUR ▶** 1 910 à 5 500 mm.
- AVANCÉE ▶** 1 600 à 3 100 mm.

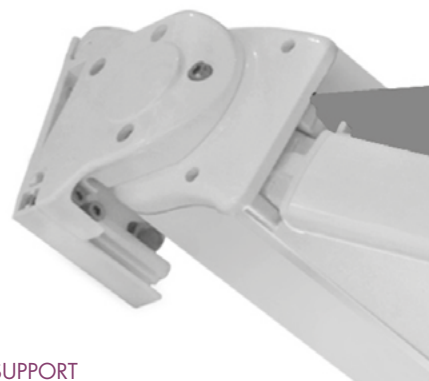

SUPPORT



NORMES



TYPES DE MANŒUVRES



OPTIONS

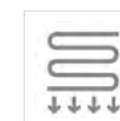



ELISSE

Store banne coffre

POUR SON DESIGN ...

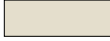
Modèle intermédiaire dans la famille des bannes coffres, avec ou sans cassette, ce produit phare grâce à son coffre spécifique peut protéger la toile indépendamment de l'armature. La banne ELISSE est disponible en 2 coloris de série : Blanc et Perle mais aussi en laquages spécifiques en option.

- COLORIS ▶** Blanc Ral 9010 
 Perle Ral 10133 
 Laquage Ral spécifique 
- LARGEUR ▶** 2 050 à 5 910 mm.
- AVANCÉE ▶** 1 600 à 3 600 mm.



SUPPORT



NORMES



TYPES DE MANŒUVRES



OPTIONS



OPTIMA

Store banne coffre

POUR LES GRANDES DIMENSIONS ...

Cette banne coffre offre une avancée optimale grâce à ses bras à chaîne : 4 350 mm pour 11 820 mm de largeur. Le modèle OPTIMA est disponible en Perle et peut-être équipé de nos kits chauffage, lumière et musique.

COLORIS ▶ Perle Rol 1013



LARGEUR ▶ 2 220 à 11 820 mm.

AVANCÉE ▶ 1 600 à 4 350 mm.

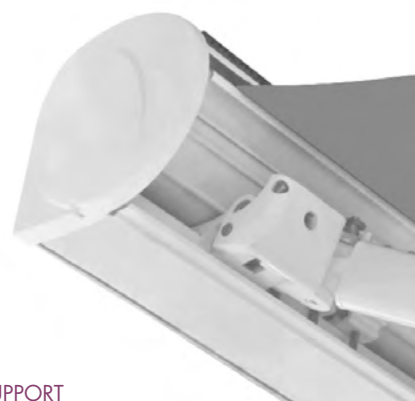

SUPPORT



NORMES



TYPES DE MANOEUVRES



OPTIONS



ARMONY PLUS

Store banne coffre

NOTRE HAUT DE GAMME TOUTES OPTIONS ...

Avec son système de repliement assurant une fermeture hermétique du coffre, l'ARMONY PLUS se positionne dans le haut de gamme de la famille des coffres. Disponible en 4 coloris de série : Blanc, Perle, Gris Fine Structure et Noir Sablé, elle peut également être déclinée dans un large choix de coloris spécifiques. L'ARMONY PLUS dispose comme option d'un lambrequin déroulable manuel ou motorisé, ainsi que des kits lumière, musique et chauffage.



- COLORIS ▶**
- Blanc Ral 9010 
 - Perle Ral 1013 
 - Gris Ral 7016 FS 
 - Noir Sablé 
 - Laquage Ral spécifique 
- LARGEUR ▶** 2 080 à 11 780 mm.
- AVANCÉE ▶** 1 600 à 4 100 mm.

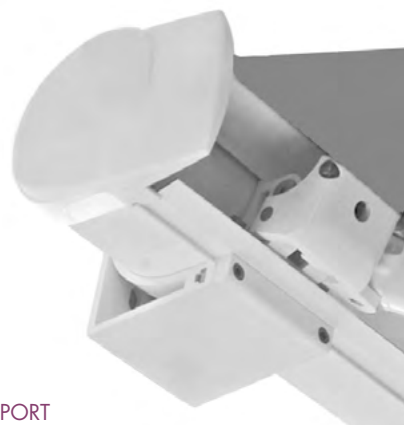

SUPPORT

NORMES



TYPES DE MANŒUVRES



OPTIONS

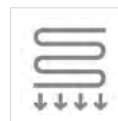
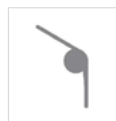



VERANDA

Store véranda

S'INTÉGRERA PARFAITEMENT À VOTRE VÉRANDA ...

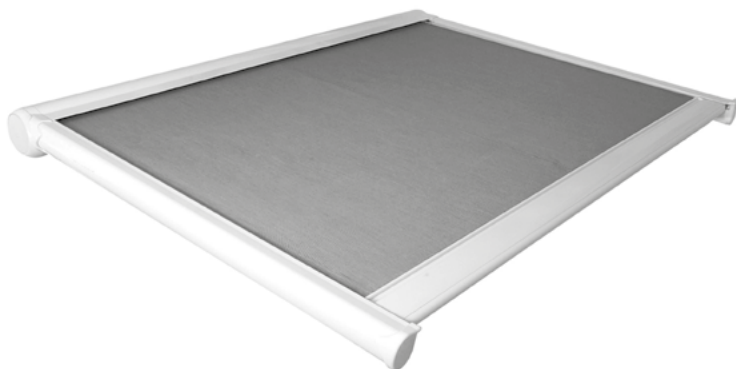
Que ce modèle soit en bois ou en aluminium, vous l'apprécierez encore plus avec un store motorisé ! Nos modules inclinés ou horizontaux, associés avec différents types de toiles vous offriront une protection améliorant votre confort. Ce modèle est disponible en 4 coloris de base : Blanc, Perle, Marron et Gris Fine Structure, mais peut aussi être laqué en option dans d'autres coloris.



COLORIS ▶	Blanc Ral 9010	
	Perle Ral 1013	
	Gris Ral 7016 FS	
	Marron Ral 8017	
	Laquage Ral spécifique	

LARGEUR ▶ 1 300 à 10 000 mm.

AVANCÉE ▶ 1 300 à 5 000 mm.



SUPPORT

NORMES



TYPES DE MANŒUVRES



OPTIONS

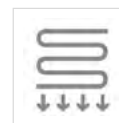

VERANDA PLUS

Store véranda

RÉALISABLE SUR 4 PIEDS ...

Ce modèle assurera en toute simplicité votre besoin de créer une zone protégée de la pluie et du soleil sur votre terrasse. Allant jusqu'à 5 000 mm d'avancée pour 10 000 mm de large, il est déclinable en 4 coloris de base.



COLORIS ▶

Blanc Ral 9010



Perle Ral 1013

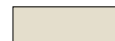

Gris Ral 7016 FS



Marron Ral 8017



Laquage Ral spécifique



LARGEUR ▶

1 300 à 10 000 mm.

AVANCÉE ▶

1 300 à 5 000 mm.



SUPPORT

NORMES



TYPES DE MANŒUVRES



OPTIONS





X-TENSION

Ce modèle, disponible en Blanc, Perle et Gris Fine Structure est une structure d'ombrage en aluminium, avec une toile rétractable par empaquetement. X-TENSION offre des dimensions allant jusqu'à 7 000 mm de largeur et jusqu'à 5 000 mm d'avancée. Une fois équipé de son joint anti-pluie, d'une toile adéquate et de sa gouttière, il est totalement imperméable. En option, il peut-être décliné dans tous les types de coloris.

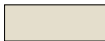

Solution d'espace couvert

- COLORIS ▶**
- Blanc Ral 9010 
 - Perle Ral 1013 
 - Gris Ral 7016 FS 
 - Laquage Ral spécifique 
- LARGEUR ▶** 2 000 à 7 000 mm.
- AVANCÉE ▶** 2 000 à 5 000 mm.



FERMETURES LATÉRALES & FRONTALES

Créez-vous un nouvel espace à vivre grâce aux solutions de fermetures latérales et frontales qui vous protégeront du vent et de la pluie !



NORMES



TYPES DE MANŒUVRES



OPTIONS





VELUM

Ce store en aluminium est équipé d'une toile rétractable par empaquetement. Conçu pour s'adapter à une structure déjà existante, il est déclinable dans 3 coloris de base mais est aussi disponible en laquage spécifique en option. Notre store VELUM est disponible en version manuelle ou motorisée. Il peut-être rendu imperméable grâce à ses options.

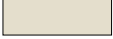

Solution d'espace couvert

- COLORIS ▶**
- Blanc Ral 9010 
 - Perle Ral 1013 
 - Gris Ral 7016 FS 
 - Laquage Ral spécifique 
- LARGEUR ▶** 2 000 à 7 000 mm.
- AVANCÉE ▶** 2 000 à 8 000 mm.



SUPPORT



NORMES



TYPES DE MANŒUVRES

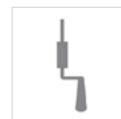

OPTIONS

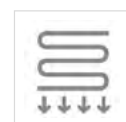

TOBAGO

Store de jardin

Quel plaisir de pouvoir recevoir en extérieur aux beaux jours, tables familiales, réception ou restauration : le TOBAGO est aussi pratique qu'accueillant. Il vous offre une grande stabilité en toute sécurité, et, agrémenté d'un pare-soleil couchant, il vous protégera jusqu'aux derniers rayons du soleil !

COLORIS ▶ Blanc Ral 9010 

LARGEUR ▶ 2 390 à 5 930 mm.

AVANCÉE ▶ 2 x 1 500 / 2 x 1 750 /
2 x 2 000 mm



AUVENT



NORMES

GARANTIE
2
ANNEES

TYPES DE MANOEUVRES

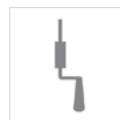

OPTIONS







DUO-PENTA STYLE

Store de jardin

Store double pentes autoportant avec un seul tube d'enroulement, le DUO-PENTA STYLE se caractérise par sa compacité et sa polyvalence. Notre store offre une couverture maximale de 34 m² dans ses dimensions les plus généreuses : 5 500 mm de largeur par 2 x 3 100 mm d'avancée. Le DUO-PENTA STYLE est disponible en 4 coloris de base et aussi en laquage spécifique en option.

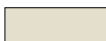

COLORIS ▶

Blanc Ral 9010	
Perle Ral 1013	
Gris Ral 7016 FS	
Noir Sablé	
Laquage Ral spécifique	

LARGEUR ▶ 1 690 à 5 500 mm.

AVANCÉE ▶ 2 x 1 600 / 2 x 2 100 mm
2 x 2 600 / 2 x 3 1000 mm



COFFRE

NORMES



TYPES DE MANŒUVRES



OPTIONS

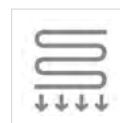

SICURA

Store de jardin

Protégez-vous facilement d'un vis-à-vis ou du vent, en créant un espace d'isolement sur mesure pour votre terrasse ou dans votre jardin, grâce au SICURA. Disponible en 3 coloris de base et déclinable dans de nombreux coloris spécifiques.

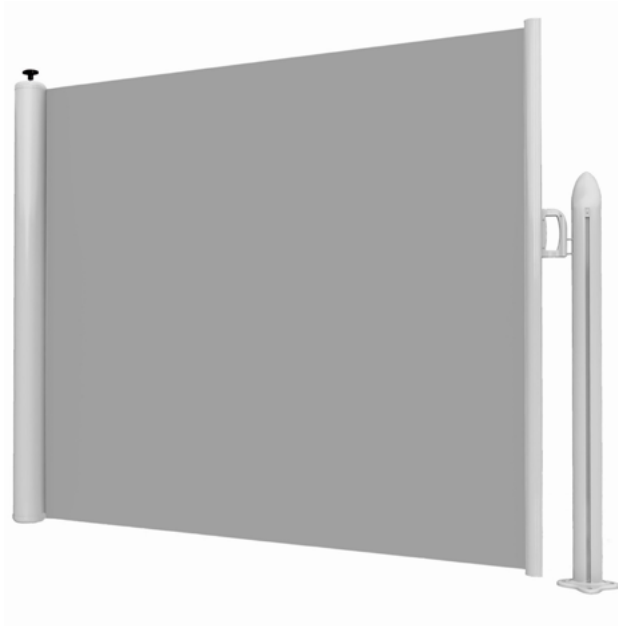

- COLORIS ▶**
- Blanc Ral 9010 
 - Perle Ral 1013 
 - Gris Ral 7016 FS 
 - Laquage Ral spécifique 

LARGEUR ▶ 1 500 à 4 000 mm.

HAUTEUR ▶ 1 200 à 2 400 mm.



COFFRE



POTEAU



SERCURE STOP



Le SICURA est enroutable en toute sécurité grâce à son système Secure Stop. Ce système de sécurité bloque la toile en cas de relâchement brutal de cette dernière.

NORMES



SALINA & LIPARI

Parasol

SALINA

Pour s'abriter élégamment du soleil avec ce parasol au design original, proposé en trois finitions de mât....

LIPARI

Ce grand parasol couvrira une surface d'ombrage de plus de 12m², avec son pied excentré, pour le bénéfice optimal de l'espace.

Inclinaison réglable (SALINA Uniquement)



COLORIS ▶ Gris argent métallisé 

Gris graphite métallisé (SALINA uniquement) 

Mixte bois/gris argent (SALINA uniquement) 

HAUTEUR ▶ Pied : 2 750 mm (SALINA)
3 100 mm (LIPARI)

Sous parasol : 2 030 mm (SALINA)
2 350 mm (LIPARI)

SURFACE ▶ 2 800 x 2 800 mm (SALINA)
3 440 x 3 440 mm (LIPARI)



NORMES

GARANTIE
2
ANNEES



ANTIQUE

Store projection

Store projection haut de gamme, avec structure en aluminium laqué et accessoires en laiton procurant une ambiance « Antique ». Ce store dispose comme option d'un auvent en aluminium et est disponible en Noir.

COLORIS ▶ Noir Ral 9005



LARGEUR ▶ 1 200 à 4 750 mm.

AVANCÉE ▶ 750 à 1 750 mm.



COFFRE



NORMES



TYPES DE MANŒUVRES

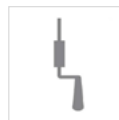

OPTIONS





CAMANOE PROJECTION

Store projection

Parfaitement adapté à l'équipement de vos fenêtres, le store CAMANOE est discret et élégant. Allant jusqu'à 3 000 mm de largeur par 1 200 mm d'avancée, ce modèle est disponible en Blanc, Perle et Anodisé mais aussi en laquage spécifique (selon la quantité).

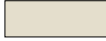

- COLORIS ▶**
- Blanc Ral 9010 
 - Perle Ral 1013 
 - Anodisé 
 - Laquage Ral spécifique 
- LARGEUR ▶** 200 à 3 000 mm.
- AVANCÉE ▶** 500 à 1 200 mm.

NORMES



TYPES DE MANOEUVRES



BANNETTE PROJECTION

Store projection

Le store projection BANNETTE saura avec ses dimensions généreuses répondre aux exigences d'équipement les plus grandes. Disponible en Blanc, Perle et Gris Fine Structure, il peut aussi être décliné dans un large choix de coloris spécifiques.



- COLORIS ▶**
- Blanc Ral 9010 
 - Perle Ral 1013 
 - Gris Ral 7016 FS 
 - Laquage Ral spécifique 
- LARGEUR ▶** 1 200 à 5 930 mm.
- AVANCÉE ▶** 800 à 1 600 mm.

NORMES



TYPES DE MANOEUVRES







CAMANOE VERTICAL

Store vertical

Répondant aux normes de protection solaire, le CAMANOE se décline en différentes finitions à même de répondre aux exigences les plus techniques. Ce modèle de store vertical a des dimensions allant jusqu'à 3 000 mm de largeur mais aussi de hauteur.



COLORIS ▶ Blanc Ral 9010 
Perle Ral 1013 
Adonisé 
Laquage Ral spécifique 

LARGEUR ▶ 200 à 3 000 mm.

HAUTEUR ▶ 200 à 3 000 mm.

NORMES



TYPES DE MANŒUVRES



BANNETTE VERTICALE

Store vertical

Comme son petit frère le CAMANOE mais dans de plus grandes dimensions, le store vertical BANNETTE est particulièrement bien adapté aux normes de protection solaire. Disponible en Blanc, Perle et Gris Fine Structure de série et aussi en laquages spécifiques en option.



COLORIS ▶ Blanc Ral 9010 
Perle Ral 1013 
Gris Ral 7016 FS 
Laquage Ral spécifique 

LARGEUR ▶ 1 200 à 5 930 mm.

HAUTEUR ▶ 800 à 4 000 mm.

NORMES



TYPES DE MANŒUVRES



TOILES



Le plus large
choix de toiles
existant...

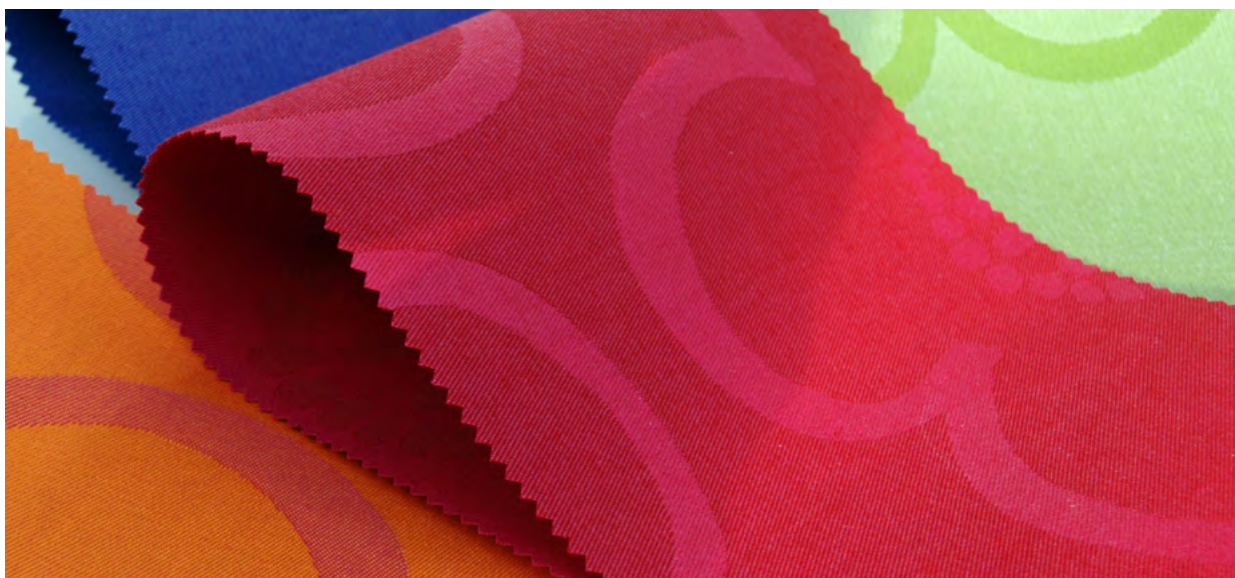

VOLETS ROULANTS RENOVATION

Volet roulant

Nos volets roulants rénovation s'adapteront sans encombre à toutes les façades. Equipés de coffres en finition pan coupé à 45° ou bien en ¼ de rond, ils sont également proposés en version motorisée. C'est la solution idéale pour la rénovation de tout type de bâtiment ...



COLORIS ▶	Ivoire Ral 1015	
	Gris Ral 7038	
	Gris Ral 9006	
	Blanc Ral 9016	
	Marron Ral 8014	

Autres coloris disponibles sur demande

LARGEUR ▶ 400 à 3 800 mm
(selon modèle de lames).

HAUTEUR ▶ 400 à 3 500 mm.

LAMES ▶ STA 37 / STA 45 / SSE 42
SEC 38 / SEC 37



NORMES



TYPES DE MANŒUVRES



VOLETS ROULANTS TRADITIONNELS

Volet roulant

Disponible avec des flasques de 110 ou 150 mm, nos modèles de volets roulants traditionnels s'installent facilement grâce à un mécanisme autoporté sur coulisses. Ils s'intégreront parfaitement à votre nouvelle façade et à tout type de construction neuve ...



COLORIS ▶ Gris Ral 7038



Blanc Ral 9016



Autres coloris disponibles sur demande

LARGEUR ▶ 400 à 3 000 mm
(selon modèle de lames).

HAUTEUR ▶ 400 à 3 500 mm.

LAMES ▶ STA 37 / STA 45



NORMES



TYPES DE MANŒUVRES

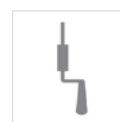

ELENA - DIONISIO - ELISSA

Marquises

En structures fixes, faciles à poser, les MARQUISES protègent et décoorent efficacement votre porte d'entrée ou tout autre espace, s'adaptant à tous les styles de bâtiments ; jouez sur la finition (Blanc ou Noir Sablé) et sur les 3 aspects de transparence de ses panneaux (transparent, fumé ou opaque).

NORMES



COLORIS ▶ Blanc Ral 9010



Noir Sablé



Laquage Ral spécifique



ELENA



LARGEUR ▶ 1 000 à 2 800 mm

AVANCÉE ▶ 760 à 2 160 mm

RAYON ▶ 400 à 5 000 mm



DIONISIO

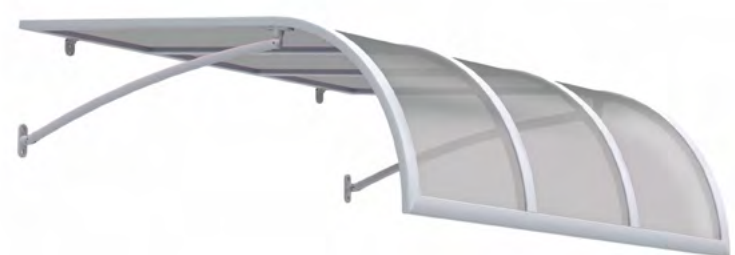

LARGEUR ▶ 760 à 4 960 mm

AVANCÉE ▶ 800 à 1 600 mm



ELISSA



LARGEUR ▶ 760 à 4 960 mm

AVANCÉE ▶ 800 à 1 600 mm



NOTES



Cachet distributeur



Retrouvez toutes les infos sur notre site internet :
www.kefrance.fr

